

PS-11

Canadian Model
E Model
AEP Model
UK Model



AUTOMATIC STEREO TURNTABLE SYSTEM

SPECIFICATIONS

GENERAL

Power Requirements: 120 V ac, 60 Hz (Canadian model)
110, 120, 220, or 240 V ac adjustable,
50/60 Hz (E, AEP, UK model)

Power Consumption: 6 W

Dimensions: Approx. 446 (w) x 140 (h) x 374 (d) mm
17½ (w) x 5½ (h) x 14¾ (d) inches

Weight: Approx. 6.1 kg, 13 lb 7 oz (net)
Approx. 7.1 kg, 15 lb 10 oz (in shipping carton)

TURNTABLE

Platter: 32.6 cm (12⅞ inches) dia.
Aluminum-alloy diecast

Motor: DC servo-controlled motor (brushless and slotless)

Drive System: Direct drive

Speeds: 33⅓, 45 rpm

Pitch Control Range: ± 4 %

Wow and Flutter: 0.03 % (WRMS)
± 0.045 % (DIN)

S/N Ratio: 70 dB (DIN-B)

TONEARM

Type: Statically balanced, universal

Pivot-to-Stylus Length: 216.5 mm, 8½ inches

Overall Arm Length: 300 mm, 11¾ inches

Overhang: 16.5 mm, ⅔ inches

Tracking Error: +3°, -1°

Tracking-Force Adjustment Range: 0 - 3g

Shell Weight: 7.5 g

Cartridge Weight Range: 4 - 12 g

— Continued on next page —

SAFETY-RELATED COMPONENT WARNING!!

COMPONENTS IDENTIFIED BY SHADING ON THE SCHEMATIC DIAGRAMS AND IN THE PARTS LIST ARE CRITICAL TO SAFE OPERATION. REPLACE THESE COMPONENTS WITH SONY PARTS WHOSE PART NUMBERS APPEAR AS SHOWN IN THIS MANUAL OR IN SUPPLEMENTS PUBLISHED BY SONY.

SONY®

SERVICE MANUAL

CARTRIDGE (VL-32G) (E, AEP, UK model and Canadian model with cartridge)

Type: Moving magnet type

Frequency Range: 10 – 30,000 Hz

Channel Separation: 25 dB (1 kHz)

Output Voltage: 3 mV (1 kHz, 5 cm/sec, 45°)

Load Impedance: 50 kΩ

Tracking Force: 1.5 – 2.5 g (2 g recommended)

Stylus: Sony ND-134G
(Conical 0.5 mil diamond)

Weight: 5.5 g

- **MODEL IDENTIFICATIONS**

– Specification Label –

Canadian model

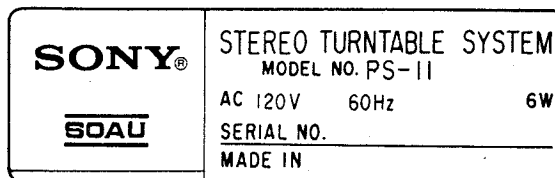

E, AEP, UK model

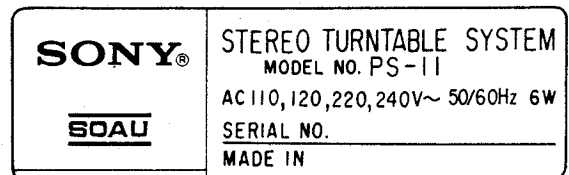

– Power Cord –

E model: euro-plug

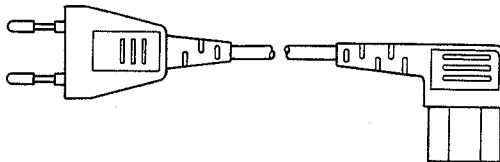

E model: parallel blade plug

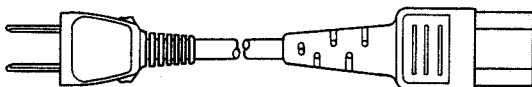

For Service Manuals
MAURITRON SERVICES
 8 Cherry Tree Road, Chinnor
 Oxfordshire, OX9 4QY.
 Tel (01844) 351694
 Fax (01844) 352554
 email- mauritron@dial.pipex.com

SECTION 1 OUTLINE

1-1. BLOCK DIAGRAM

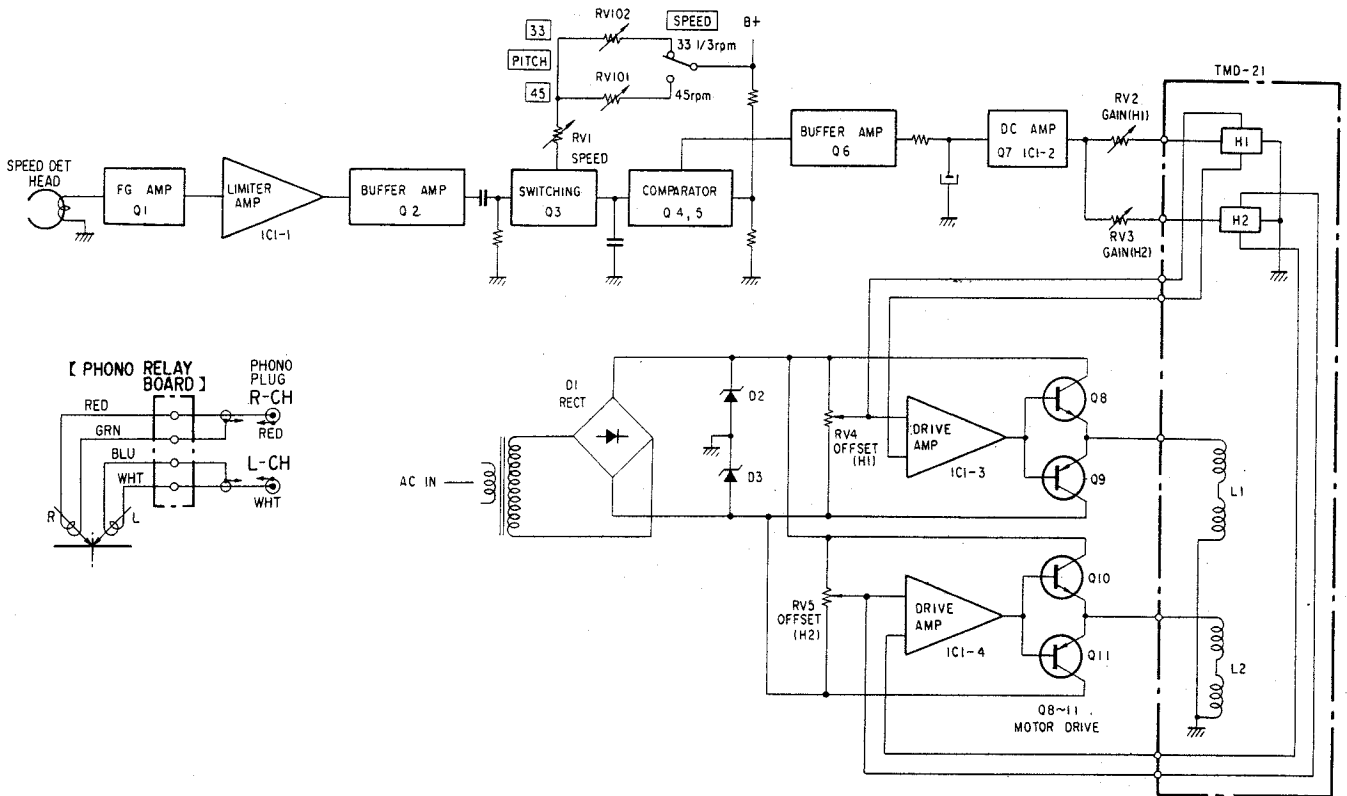

1-2. HALL MOTOR (TMD-21)

Adoption of the BSL (brushless and slotless) DC servo motor has the following major advantages.

- 1) Very little noise due to the elimination of mechanical contacts, and current control by electronic switching.
- 2) Stable performance and very long operational life.

The operating principles of the Hall Motor (TMD-21) are described below.

- **Hall Element (VHE-510)**

The magnetic field strength is converted into electrical signals by employing the Hall Effect *.

* The Hall Effect: When a current I flows through a substance, and a magnetic field B is applied at right angles to the direction of current flow, a potential difference V will be generated in a direction at right angles to both the current and magnetic field. (See Fig. 1-1.)

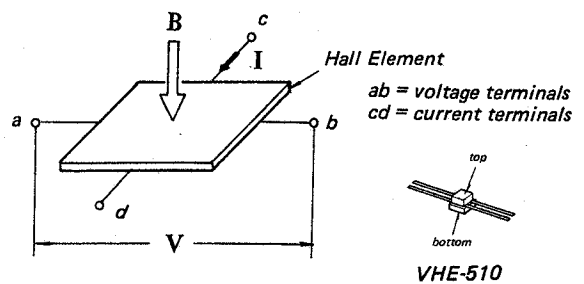

Fig. 1-1.

Note: There is no distinction between voltage and current terminals in the VHE-510 Hall Element.

• Motor Drive

The TMD-21 Hall Motor employs the Hall Element to detect the position of magnets. When an N pole is positioned opposite the Hall Element H1 in Fig. 1-2, a positive voltage is generated in H1. This voltage is then amplified in IC1-3, and then applied to Q8 after passing through R31. Once Q8 is turned ON, B+ voltage is applied to L1. The current flowing through L1, and the magnet's magnetic field, produce a magnetic force and rotates the rotor in the direction of the arrow.

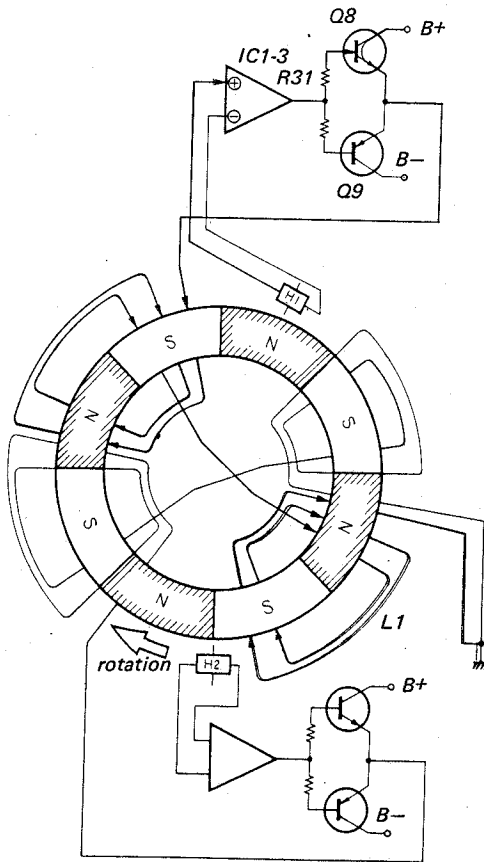

Fig. 1-2.

When the rotor rotates by $22^\circ 30'$, an S pole is positioned opposite the Hall Element H2 in 1-3, thus resulting in the generation of a negative voltage in H2. This voltage is amplified by IC1-4, passed through R36, thus turning Q11 ON, resulting in B- voltage being applied to L2. The current flowing through L2, and the magnet's magnetic field, produce a magnetic force, again in the same direction as before.

Therefore, N poles and S poles are repeatedly positioned opposite H1 and H2 Hall Elements respectively every 45° of a rotation, resulting in the generation of the voltages in H1, H2 which are used to produce the force required to rotate the rotor.

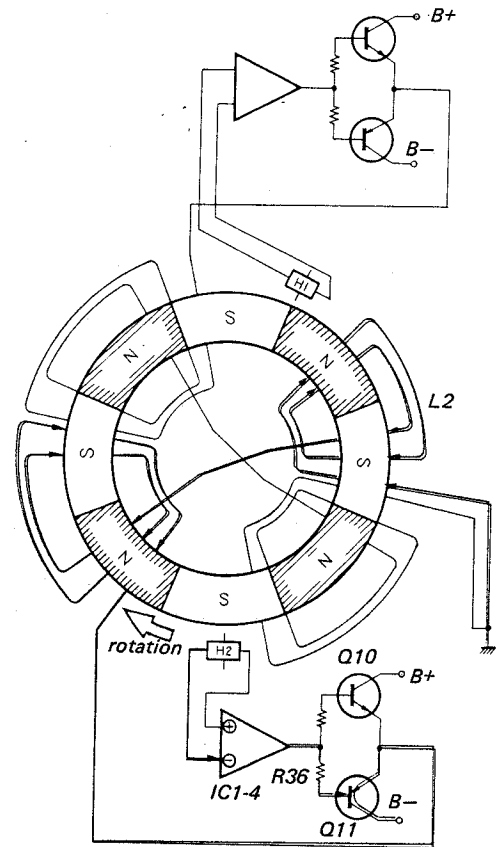

Fig. 1-3.

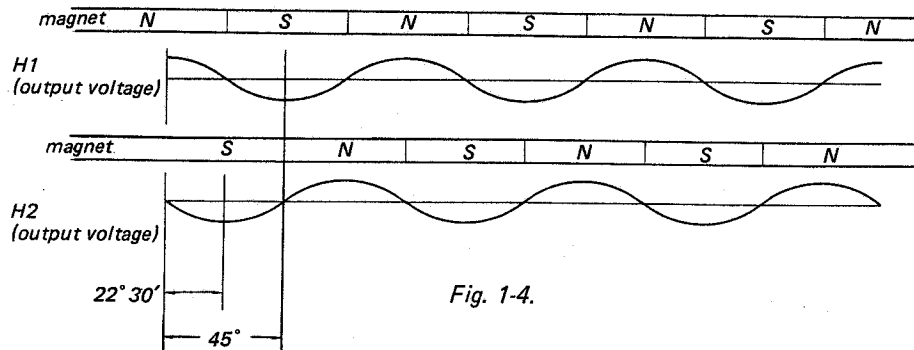
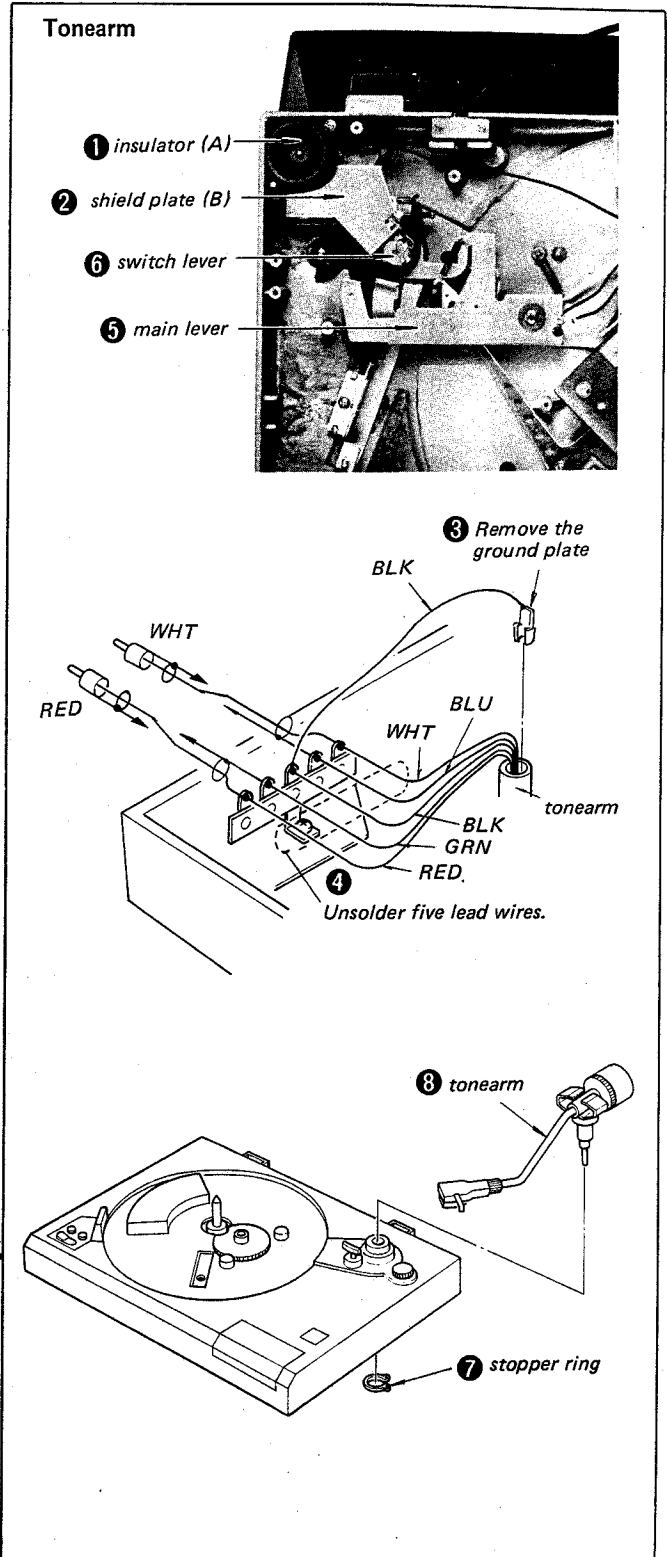
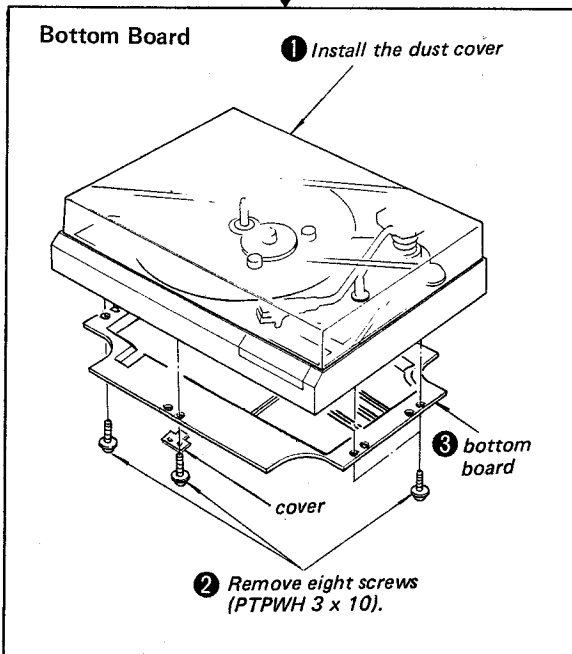
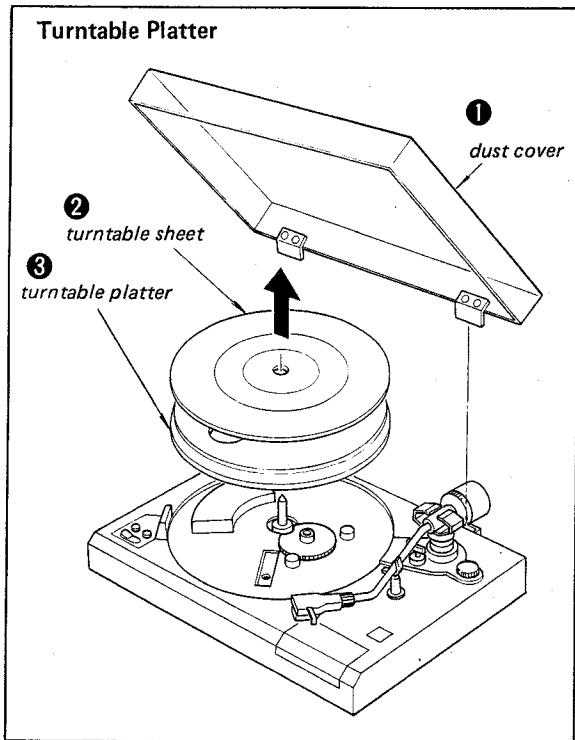

Fig. 1-4.

SECTION 2 DISASSEMBLY

2-1. REMOVAL



Cartridge Replacement (VL-32G)

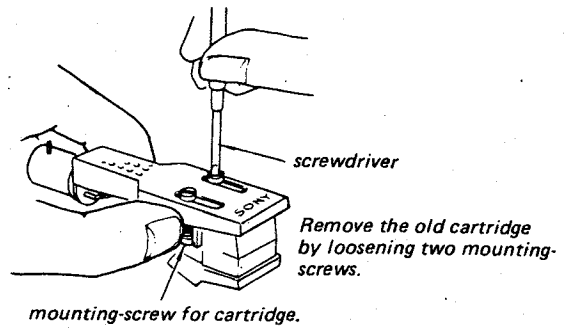
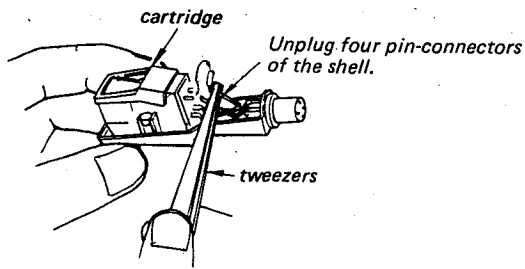

Connection of lead wires.

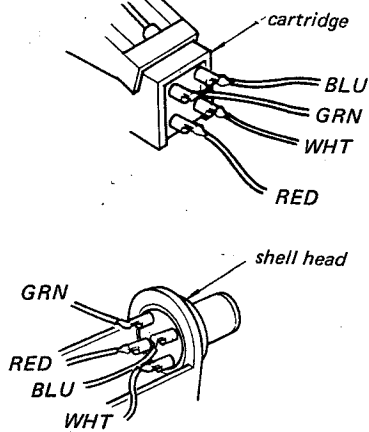

Fasten the screws lightly so that the cartridge can slide for adjustment.

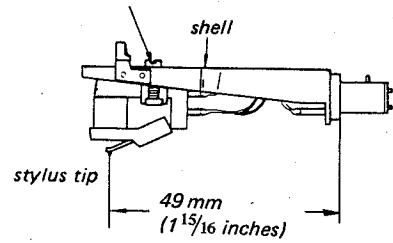

Motor

① Remove the lug.

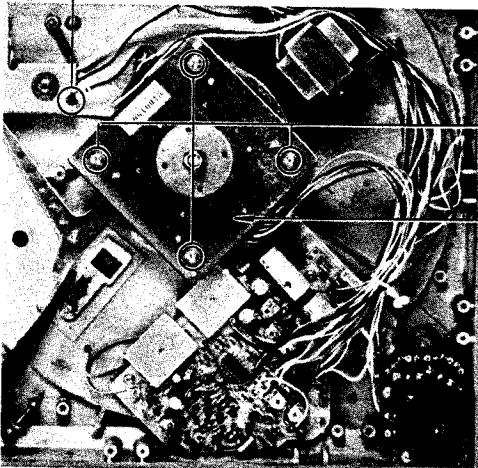

② Remove four screws (PTPWH 4 x 12).

③ Remove the motor.

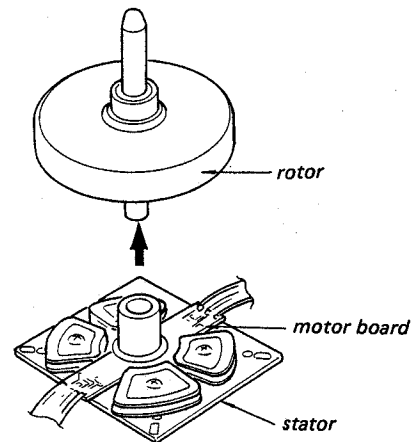

SECTION 3 ADJUSTMENTS

3-1. MECHANICAL ADJUSTMENTS

Tonearm Height Adjustment

A). Automatic Return Operation

1. Bring the tonearm toward the inner of the record and put the stylus in the last groove of the record.
2. Slowly turn the turntable by hand to lift the tonearm.
3. Confirm that the clearance between the stylus tip and the record is 7 – 12 mm as shown in Fig. 3-1. If necessary, adjust the height of the arm lifter by loosening the set screw.
4. After the adjustment, confirm that the tonearm smoothly returns to the tonearm rest as shown in Fig. 3-2.

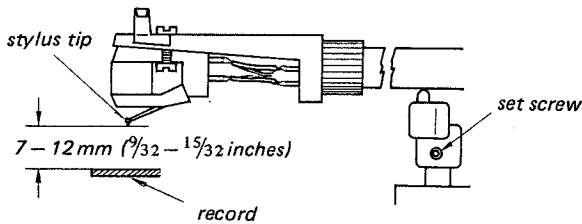

Fig. 3-1.

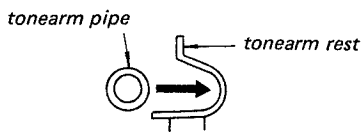

Fig. 3-2.

B). Manual Return Operation

1. Bring the tonearm to the desired position on the record.
2. Lift the cueing lever and confirm that the clearance between the stylus tip and the record is 7 – 12 mm as shown in Fig. 3-1. If necessary, bend the seesaw plate and adjust the height of the tonearm by turning the adjustment screw.

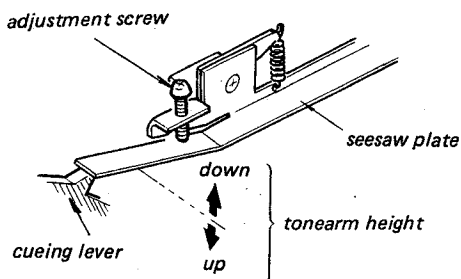

Fig. 3-3.

Automatic Return Position Adjustment

1. Perform the REJECT operation once.
2. If the automatic return operation does not work properly, adjust by turning the adjustment screw as shown in Fig. 3-4.

Turning direction	Automatic return position
<p>1</p> <p>↓</p> <p>2</p>	<p>slow</p> <p>↓</p> <p>fast</p>

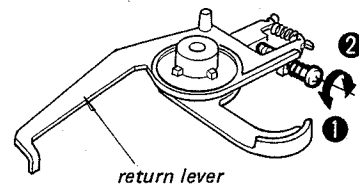
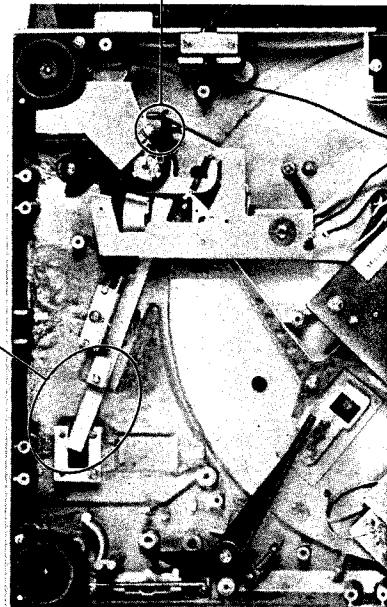
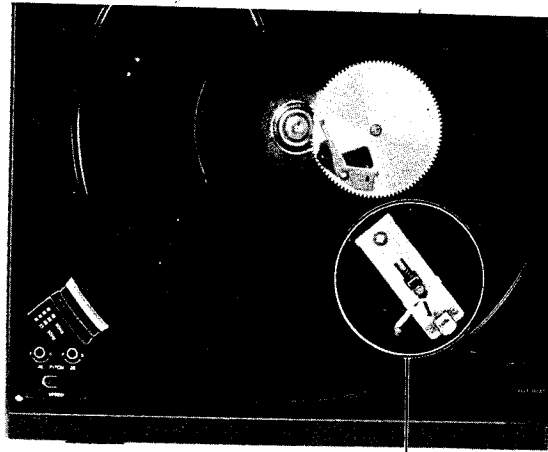
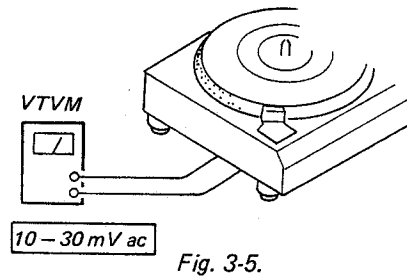
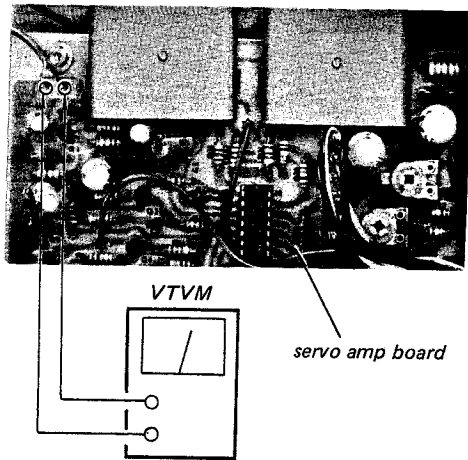

Fig. 3-4.





Speed Detecting Head Position Adjustment



1. Remove the turntable platter.
2. Set the head deck as shown in Fig. 3-6.
3. Install the turntable platter.
4. Set the SPEED selector switch (S2) to 33 position.
5. Adjust the PITCH control (33) so that the stroboscope pattern appears stationary.
6. Confirm that the VTVM reads 10 - 30 mV ac. If necessary, adjust the position of the head deck by loosening the adjustment screw.

Note: Confirm that the head does not touch the turntable platter.

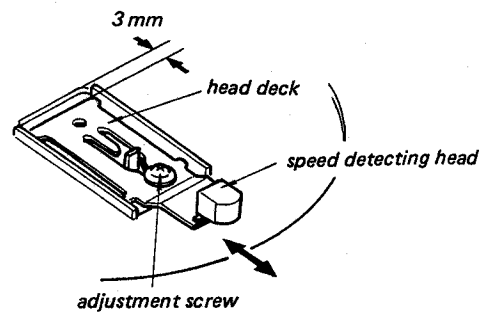

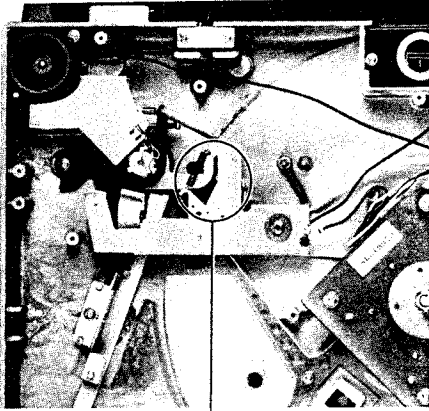

Tonearm Lever Position Adjustment

1. Secure the tonearm to the arm rest.
2. Set the drive gear to OFF position as shown in Fig. 3-7.
3. Install the tonearm lever as shown in Fig. 3-8.

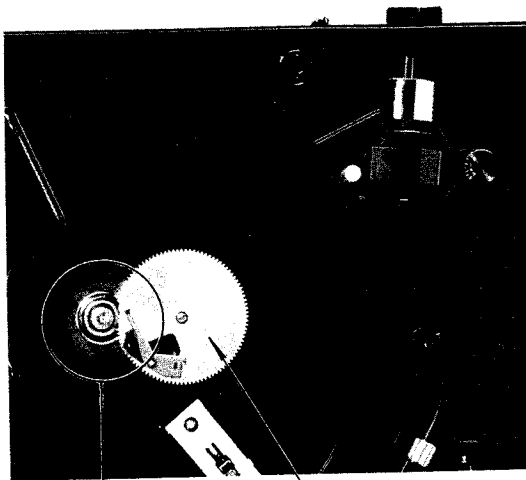

OFF position

drive gear

Fig. 3-7.

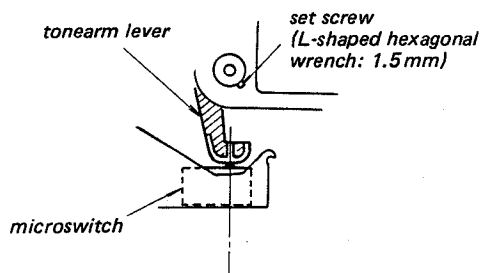

Fig. 3-8.

For Service Manuals
MAURITRON SERVICES
 8 Cherry Tree Road, Chinnor
 Oxfordshire, OX9 4QY.
 Tel (01844) 351694
 Fax (01844) 352554
 email:- mauritron@dial.pipex.com

3-2. ELECTRICAL ADJUSTMENTS**Turntable Speed Adjustment**

If correct speed cannot be obtained by adjusting the PITCH controls, adjust RV1.

1. Set the two PITCH control knobs (33 and 45) to the mechanical-mid position.
2. Set the SPEED selector switch to "33" or "45" position and adjust RV1 so that the stroboscope pattern appears stationary.

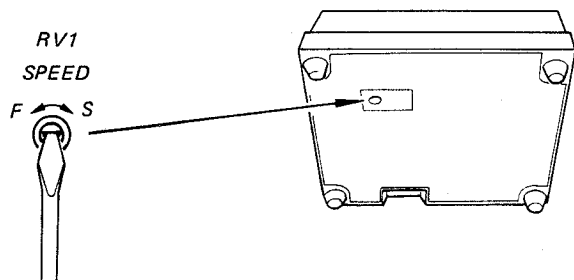

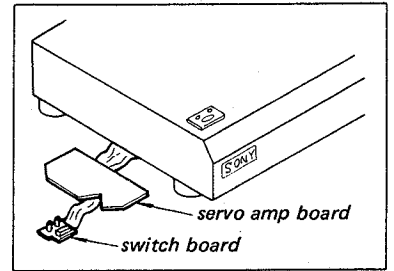
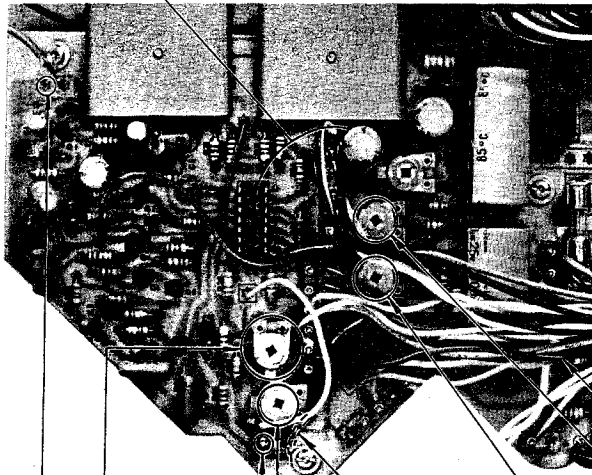
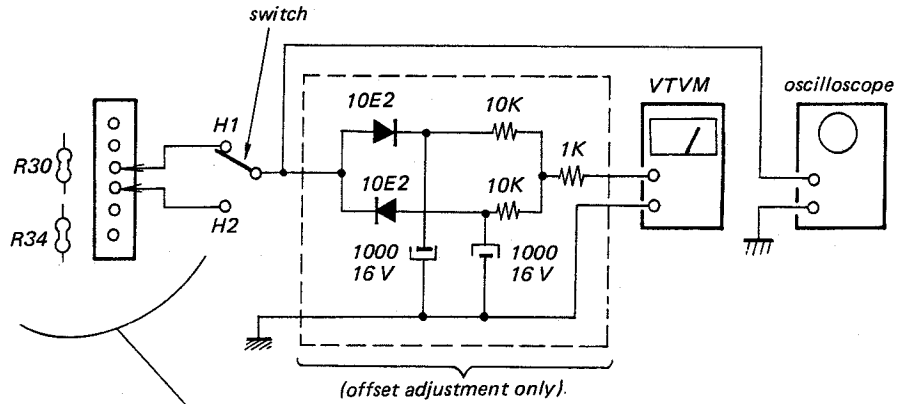

regulated power supply

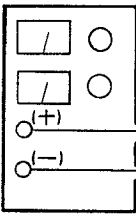

2 V dc

RV2 (H1)

RV3 (H2)

RV5 (H2)

RV4 (H1)

Motor Gain Adjustment

1. Turn the switch to H1 position and adjust RV2 for 2.3 V ac VTVM reading.
2. Turn the switch to H2 position and adjust RV3 for 2.3 V ac VTVM reading.

Offset Adjustment

Note: Offset means the unbalanced voltages of the hall element and IC. When the offset voltage has changed, it causes the wow and flutter.

1. Turn the switch to H1 position and adjust RV4 for 0 V dc VTVM reading or screen pattern of oscilloscope.
2. Turn the switch to H2 position and adjust RV5 for 0 V dc VTVM reading or screen pattern of oscilloscope.

Oscilloscope screen pattern:

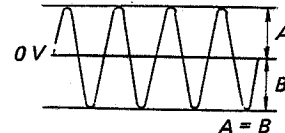

SECTION 4 DIAGRAMS

4-1. MOUNTING DIAGRAMS - Conductor Side -

• Replacement Semiconductors

For replacement, use semiconductors except in ().

Q1-5, 7: 2SC634A

(2SC945)

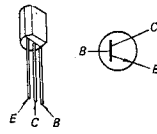
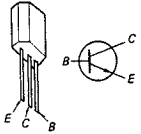

Q6: 2SA678

(2SA733)

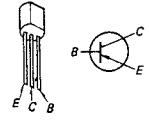
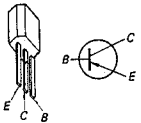

Q8, 10: 2SC1061

(2SC1419)

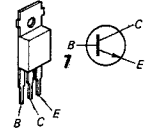
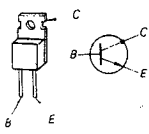

Q9, 11: 2SA671 (2SA755)

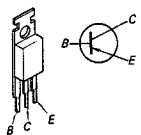

D1: 1SRB10

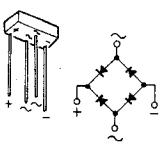

D2, 3: EQB01-13 (EQA01-13R)

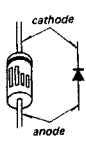

IC1: μ PC324C

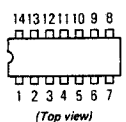

H1, 2: VHE-510

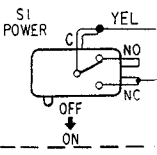
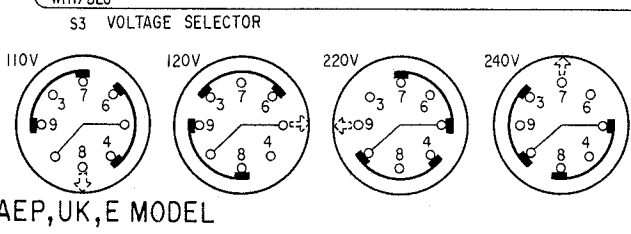
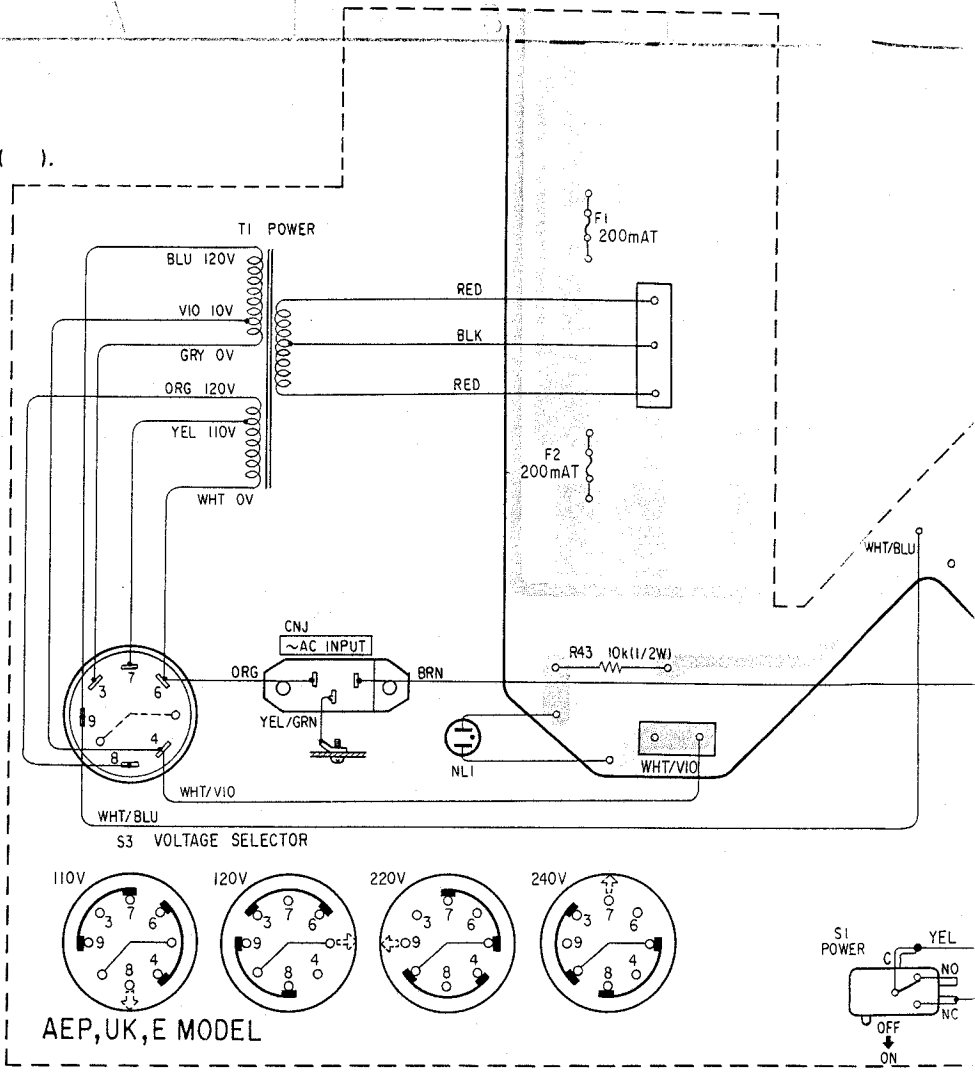
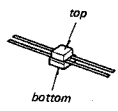

- WAVE FORMS OF IC1 -

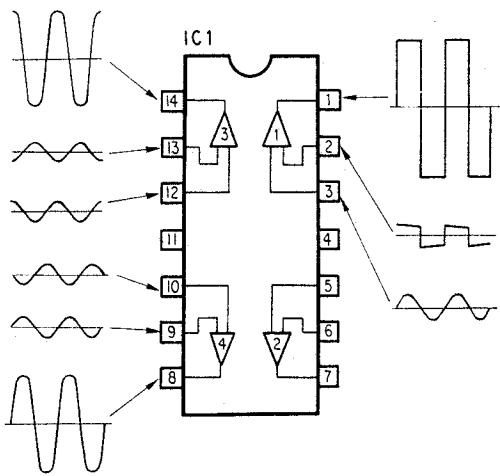

Note:

- Color code of sleeving over the end of the jacket.
- : part mounted on the conductor side.
- : B+ pattern
- : B- pattern
- Voltages are dc with respect to ground unless otherwise noted.
- Readings are taken with a VOM (20 k Ω /V).
- SPEED selector switch: 33 $\frac{1}{3}$ rpm.

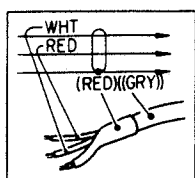

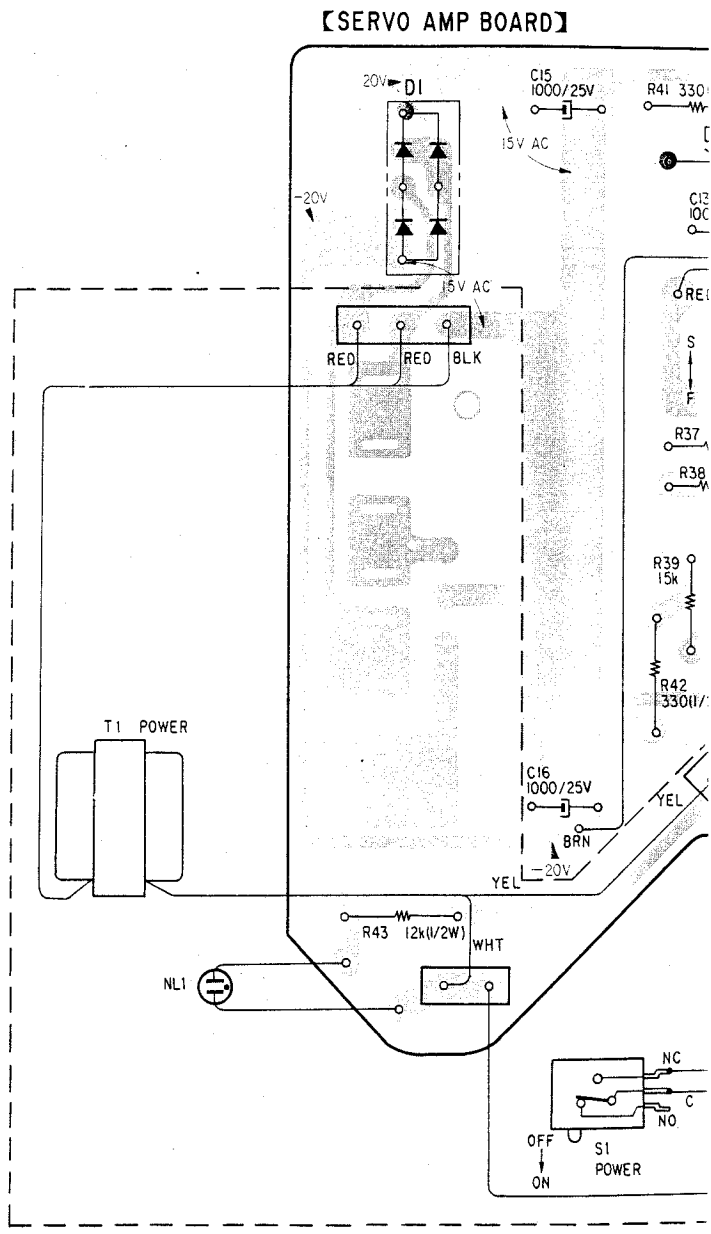
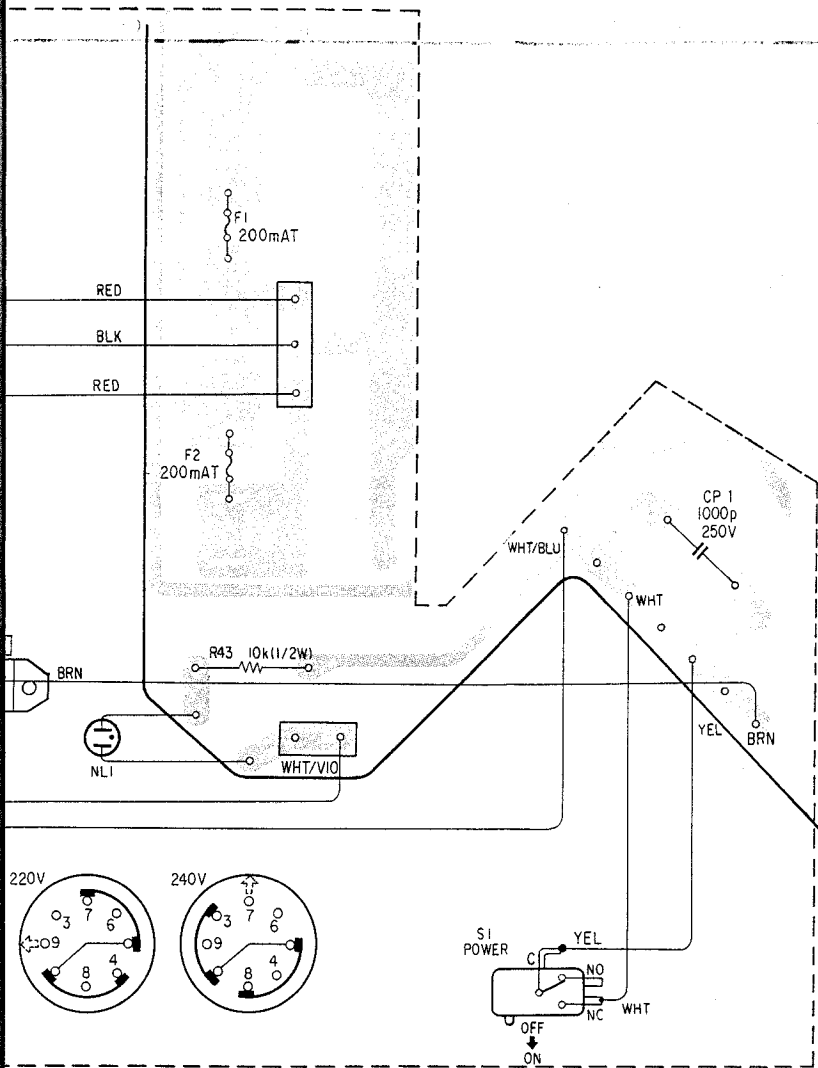

WAVE FORMS OF IC1 -

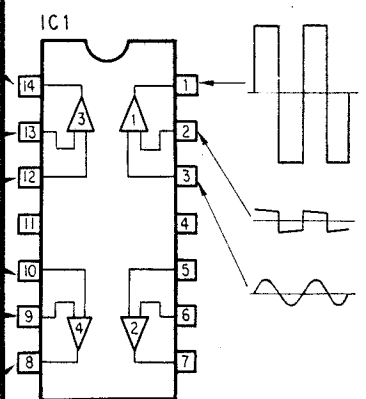

- : part mounted on the conductor side.
 - : B+ pattern
 - : B- pattern
 - Voltages are dc with respect to ground unless otherwise noted.
 - Readings are taken with a VOM (20 kΩ/V).
- SPEED selector switch: 33 $\frac{1}{3}$ rpm.

Q, IC	
D	1

【SERVO AMP BOARD】

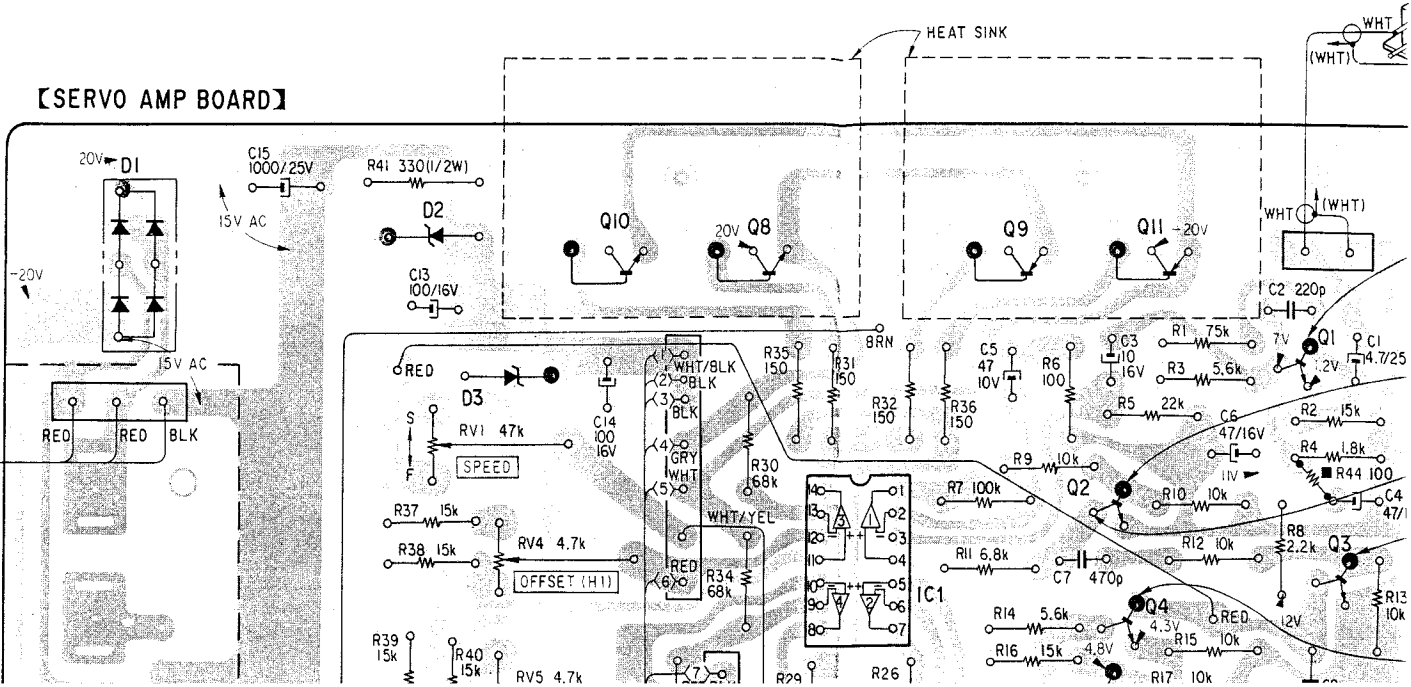

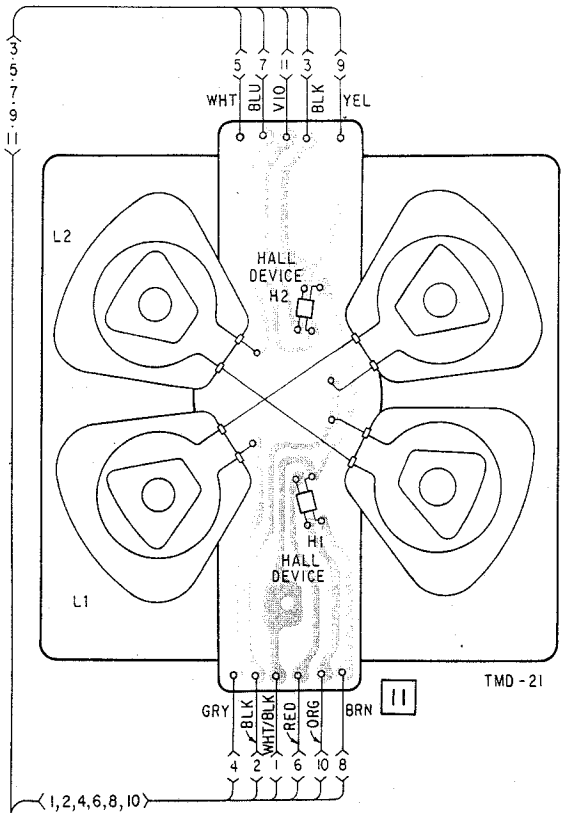
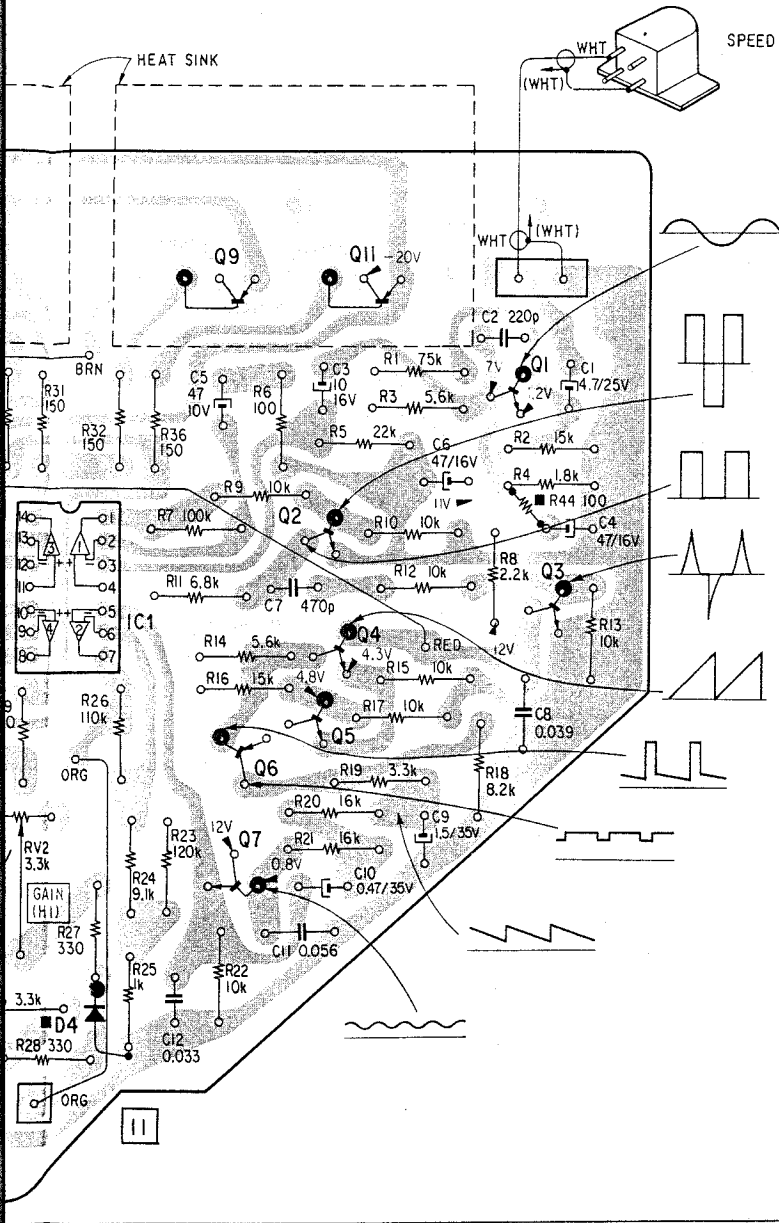

[SWITCH BOARD]

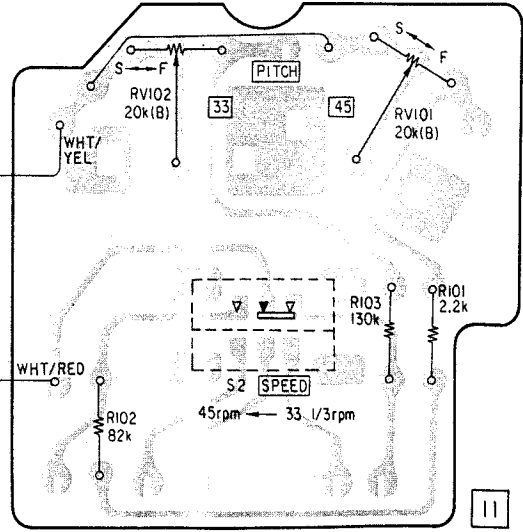

IC1	9	2	11	1
	6	5	4	3
4				

4-2. SCHEMATIC DIAGRAM

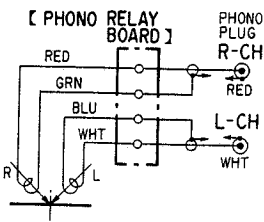
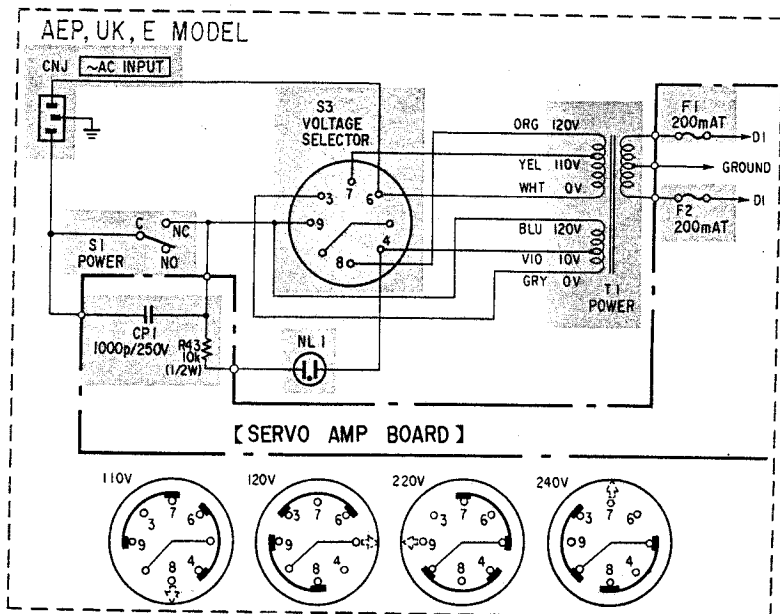
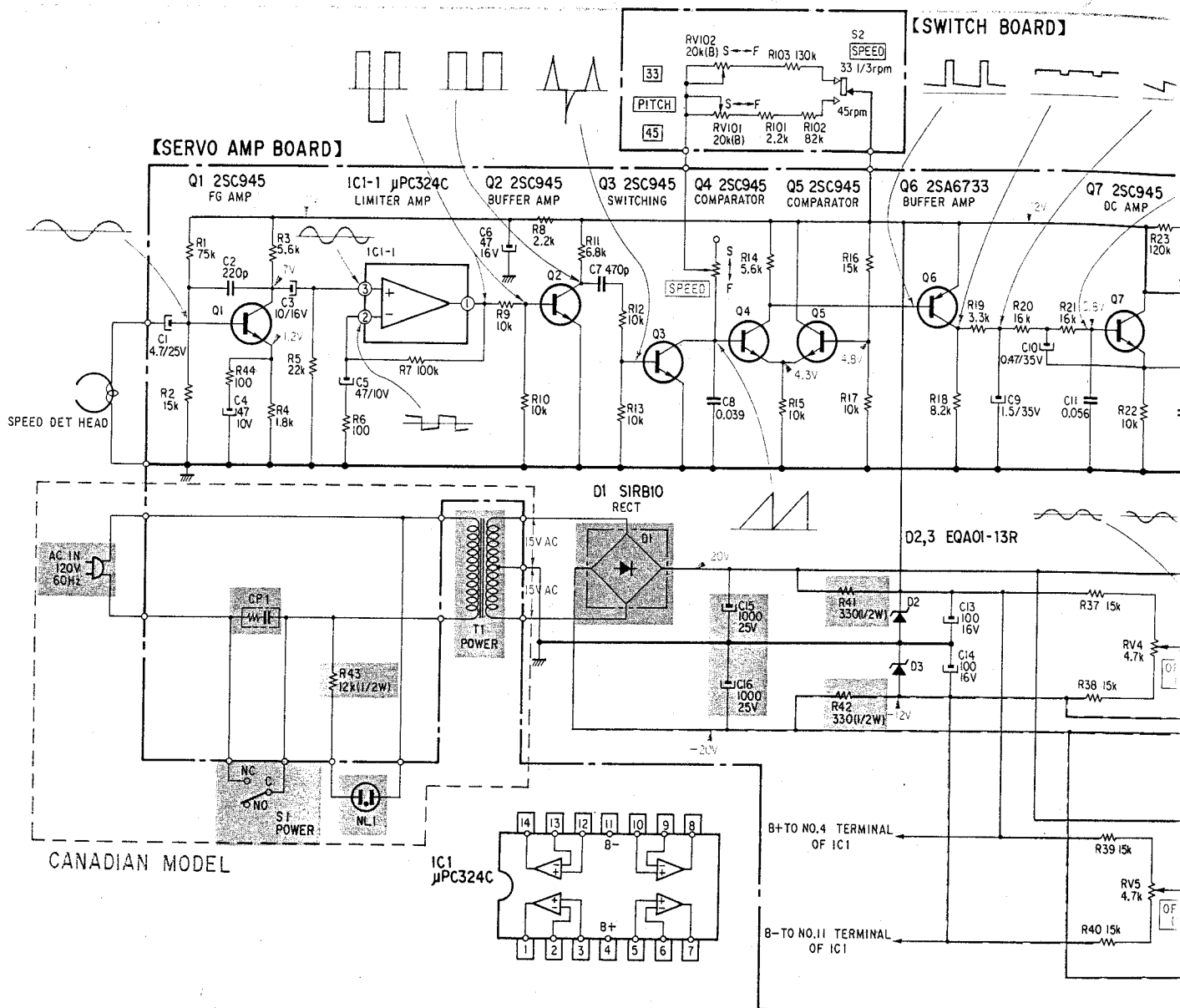

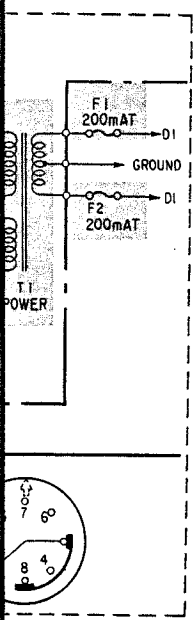
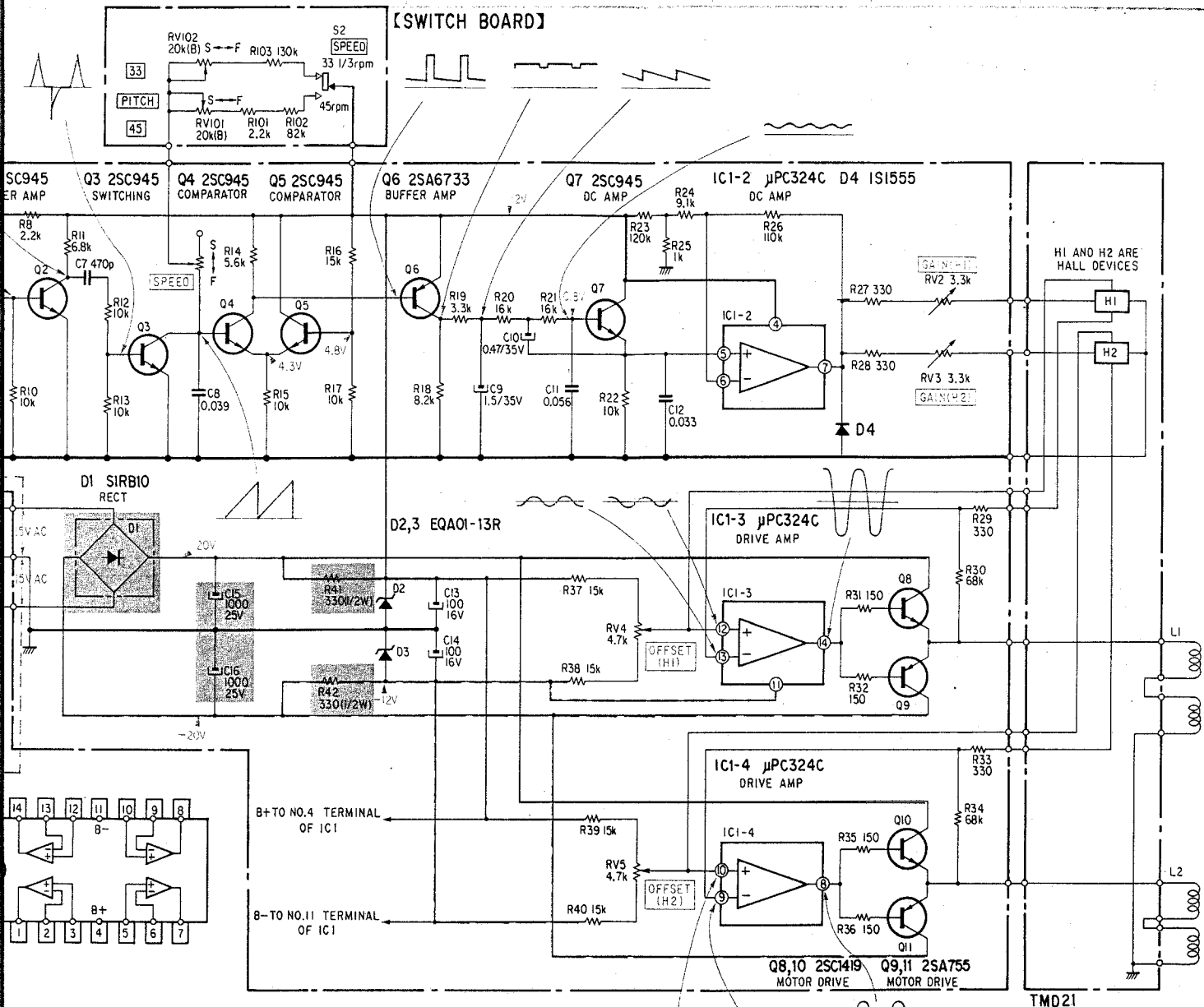

Note: The c safety

D1

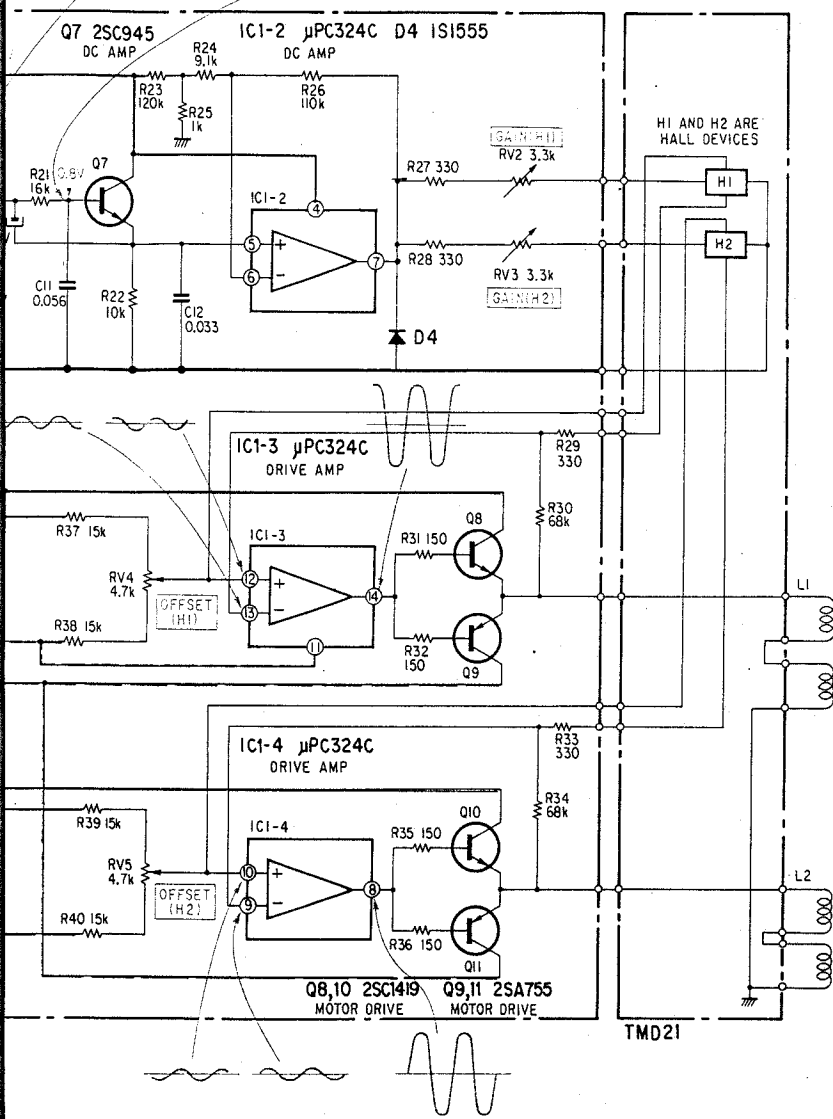

Note:

- All capacitors are in μF unless otherwise noted. $\text{pF} = \mu\mu\text{F}$. 50 WV or less are not indicated except for electrolytics.
- All resistors are in ohms, $\frac{1}{4}\text{W}$ unless otherwise noted. $\text{k}\Omega = 1000\Omega$, $\text{M}\Omega = 1000\text{k}\Omega$
- : panel designation.
- : adjustment for repair.
- Voltages are dc with respect to ground unless otherwise noted.
- Readings are taken with a VOM (20 $\text{k}\Omega/\text{V}$).
SPEED selector switch: $33\frac{1}{3}$ rpm.
- : B+ bus.
- : B- bus.
- Switch

Ref. No.	Switch	Position
S1	POWER	OFF
S2	SPEED	$33\frac{1}{3}$ rpm
S3	VOLTAGE SELECTOR (E, AEP, UK model)	—

Note: The components identified by shading are critical for safety. Replace only with part number specified.

SECTION 5
EXPLODED VIEWS

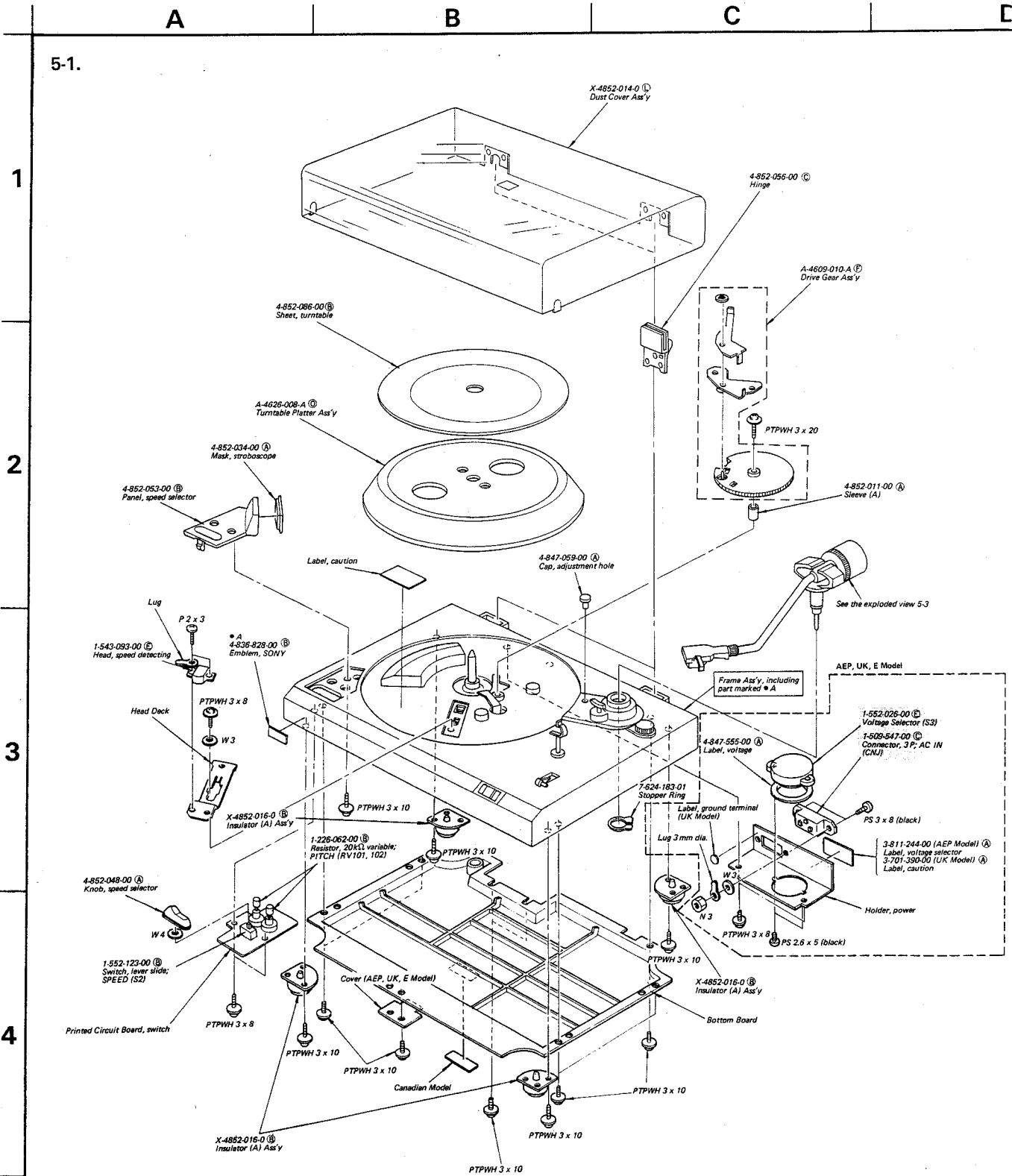

Note: The components identified by shading are critical for safety. Replace only with part number specified.

- Note:**
- Items with no part number and/or no description are not stocked because they are seldom required for routine service.
 - All screws are Phillips (cross recess) type unless otherwise noted.
(-) = slotted head
 - Circled letters (A to Z) are applicable to European models only.

5-2.

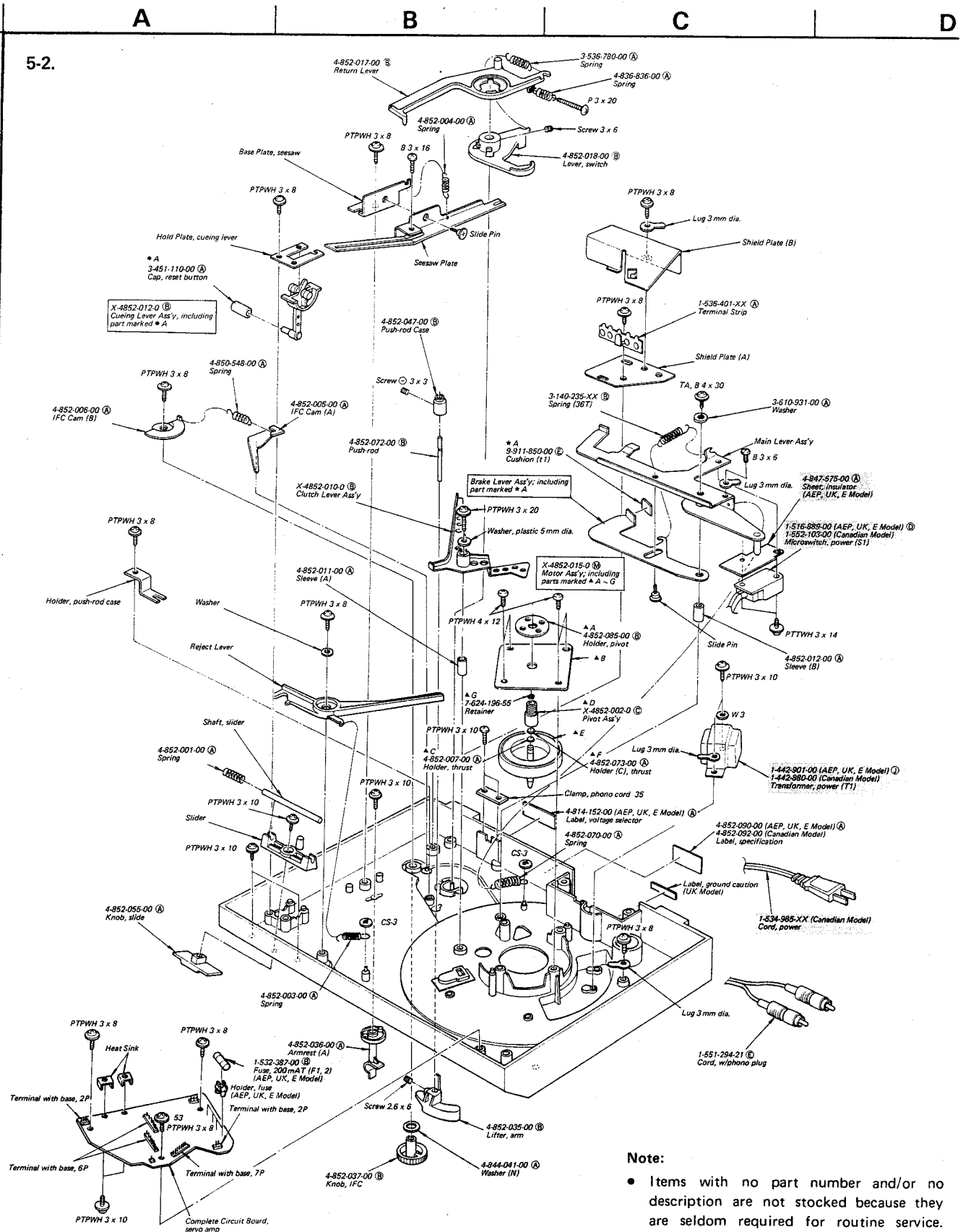

Note: The components identified by shading are critical for safety. Replace only with part number specified.

- Note:**
- Items with no part number and/or no description are not stocked because they are seldom required for routine service.
 - All screws are Phillips (cross recess) type unless otherwise noted.
(-) = slotted head
 - (□T) shows the number of coils in spring.
 - Circled letters (A) to (Z) are applicable to European models only.

5-3.

1

2

3

4

5

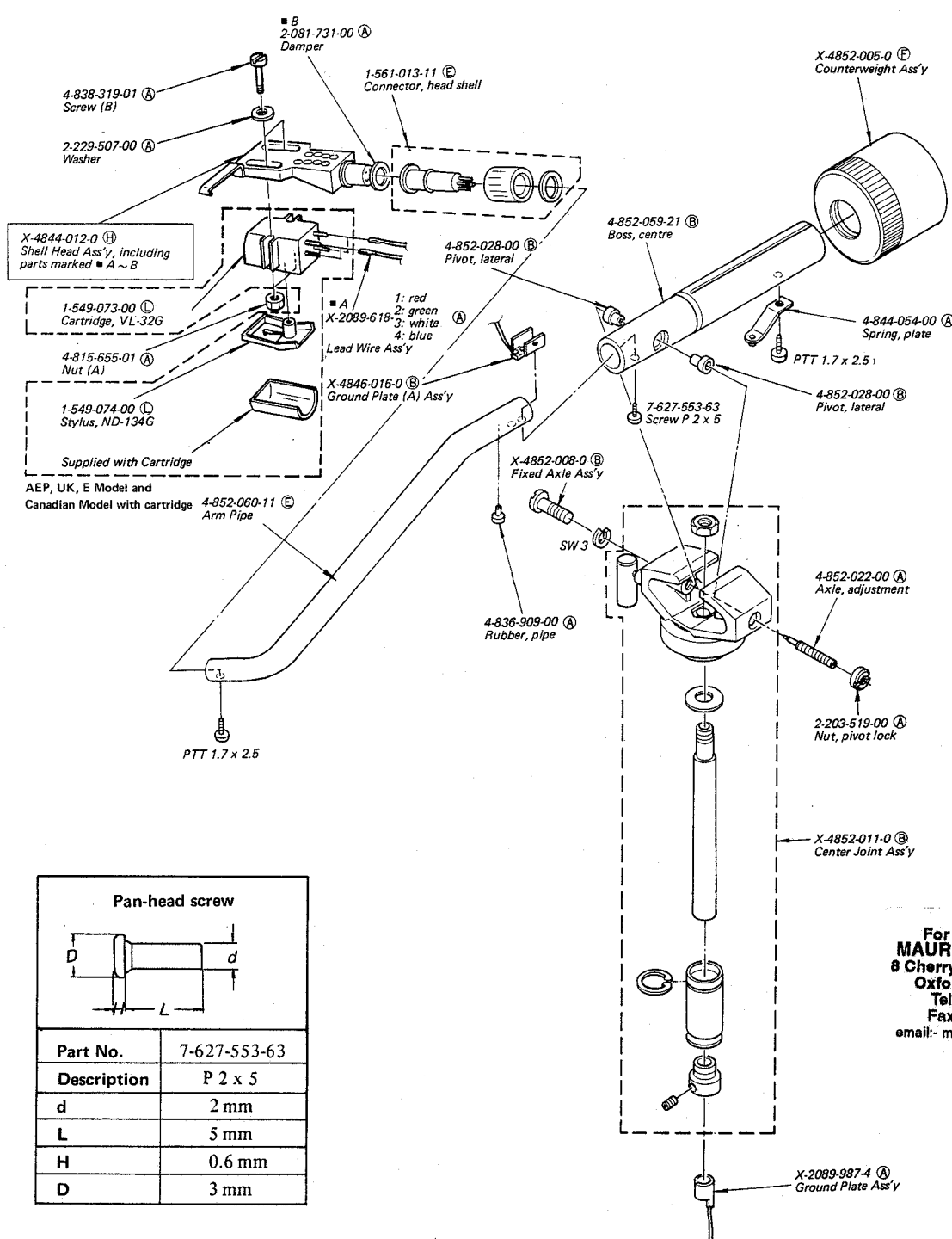

Pan-head screw	
Part No.	7-627-553-63
Description	P 2 x 5
d	2 mm
L	5 mm
H	0.6 mm
D	3 mm

For Service Manuals
MAURITRON SERVICES
 8 Cherry Tree Road, Chinnor
 Oxfordshire, OX9 4QY.
 Tel (01844) 351694
 Fax (01844) 352554
 email: mauritron@dial.pipex.com

- Note:**
- Items with no part number and/or no description are not stocked because they are seldom required for routine service.
 - All screws are Phillips (cross recess) type unless otherwise noted.
(-) = slotted head
 - Circled letters (A) to (Z) are applicable to European models only.

SECTION 6

ELECTRICAL PARTS LIST

Note: Circled letters (A) to (Z) are applicable to European models only.

Ref. No.	Part No.	Description
SEMICONDUCTORS		
Transistors		
⇒ Q1 - 5	(B) 2SC634A	
⇒ Q6	(C) 2SA678	
⇒ Q7	(B) 2SC634A	
⇒ Q8	(D) 2SC1061	
⇒ Q9	(E) 2SA671	
⇒ Q10	(D) 2SC1061	
⇒ Q11	(E) 2SA671	
IC		
IC1	(G) μ PC324C	
Diodes		
D1	(C) SIRB10	
⇒ D2, 3	(B) EQB01-13	
Hall Device		
H1, 2	(D) VHE-510	
TRANSFORMERS		
T1	1-442-880-00 Power (Canadian model) (1-442-901-00 (J) Power (E, AEP, UK model)	
CAPACITORS		
All capacitors are in μ F and ceramic unless otherwise noted. 50 WV or less are not indicated except for electrolytics. pF = μ μ F, elect = electrolytic		
C1	1-121-395-11 (A) 4.7	25 V elect
C2	1-102-110-11 (A) 220 p	
C3	1-121-651-11 (A) 10	16 V elect
C4, 5	1-121-352-11 (A) 47	10 V elect
C6	1-121-409-11 (A) 47	16 V elect
C7	1-102-114-11 (A) 470 p	
C8	1-108-811-12 (B) 0.039	mylar
C9	1-131-216-11 (B) 1.5	35 V tantalum

⇒: Due to standardization, interchangeable replacements may be substituted for parts specified in the diagrams.

Note: The components identified by shading are critical for safety. Replace only with part number specified.

Ref. No.	Part No.	Description
C10	1-131-213-11 (B) 0.47	35 V tantalum
C11	1-108-813-12 (B) 0.056	mylar
C12	1-108-810-12 (B) 0.033	mylar
C13, 14	1-121-415-11 (A) 100	16 V elect
C15, 16	1-121-657-11 (B) 1000	25 V elect
RESISTORS		
All resistors are in ohms. Common 1/4W carbon resistors are omitted. Check schematic diagram for values.		
R41, 42	1-244-861-11 (A) 330	1/2 W
R43	1-244-897-11 (A) 10 k (1-244-899-11 12 k	1/2 W (E, AEP, UK model) 1/2 W (Canadian model)
RV1	1-224-647-XX (B) 47 k,	adjustable
⇒ RV2, 3	1-224-644-XX (B) 4.7 k,	adjustable
RV4, 5	1-224-644-XX (B) 4.7 k,	adjustable
RV101, 102	1-226-062-00 (B) 20 k,	variable, PITCH
SWITCHES		
S1	1-516-889-00 (D) Micro, POWER (E, AEP, UK model) (1-552-103-00 Micro, POWER (Canadian model)	
S2	1-552-123-00 (B) Lever Slide, SPEED	
S3	1-552-026-00 (E) Voltage Selector (E, AEP, UK model)	
MISCELLANEOUS		
CNJ	1-509-547-00 (C) Connector, 3-p; AC IN (E, AEP, UK model)	
CP1	1-102-222-21 (A) Capacitor, ceramic; 1000p 250 V (E, AEP, UK model) 1-231-326-00 Encapsulated Component (Canadian model)	
F1, 2	1-532-387-00 (B) Fuse, 200 mA T (E, AEP, UK model)	
NL1	1-519-135-11 (C) Lamp, neon 1-534-985-XX Cord, power (Canadian model) 1-536-401-XX (A) Terminal Strip 1-543-093-00 (E) Head, speed detecting	
	1-549-073-00 (L) Cartridge, VL-32G (E, AEP, UK model and Canadian model with cartridge)	
	1-549-074-00 (L) Stylus (ND-134G) (E, AEP, UK model and Canadian model with cartridge)	
	1-551-294-21 (E) Cord, w/phono plug	
	1-561-013-11 (E) Connector, head shell	

Note: Circled letters (A to Z) are applicable to European models only.

ACCESSORIES & PACKING MATERIALS

<u>Part No.</u>	<u>Description</u>	<u>Part No.</u>	<u>Description</u>
X-4844-012-0	(H) Shell Head Ass'y	3-701-632-00	(A) Bag, plastic; accessory
including:		3-701-634-00	(A) Bag, plastic; turntable platter
2-081-731-00	(A) Damper, shell head	3-701-806-00	(A) Adaptor, 45 rpm
X-2089-618-1	(A) Lead Wire Ass'y (red)	3-770-244-11	(E) Manual, instruction (E, AEP, UK model)
X-2089-618-2	(A) Lead Wire Ass'y (green)	3-770-244-31	Manual, instruction (Canadian model)
X-2089-618-3	(A) Lead Wire Ass'y (white)	3-793-395-11	(A) Gauge, overhang adjustment
X-2089-618-4	(A) Lead Wire Ass'y (blue)		
1-534-754-00	Cord, power; w/parallel blade plug (E model)	4-815-655-01	(A) Nut (A), cartridge
1-534-819-00	(G) Cord, power (UK model)	4-838-319-01	(A) Screw (B), cartridge
1-551-216-00	Cord, power; w/euro-plug (E model)	4-843-577-00	(A) Sheet, protection; dust cover
		4-847-314-00	(C) Bag, plastic; set
2-054-619-00	(A) Spacer, cartridge	4-852-077-00	(A) Protector, counterweight
2-054-624-01	Screw (B), cartridge (Canadian model without cartridge)	4-852-078-00	(B) Holder, turntable platter
2-054-625-00	Screw (A), cartridge (Canadian model without cartridge)	4-852-080-00	(B) Cushion, upper
		4-852-081-00	(B) Cushion, lower
3-701-438-21	Washer, plastic; 2.5 mm dia (Canadian model without cartridge)	4-852-095-00	Carton (E, AEP, UK model and Canadian model with cartridge)
3-701-613-00	(A) Bag, plastic; cartridge screws	4-852-096-00	Carton (Canadian model without cartridge)
3-701-616-00	(A) Bag, plastic; counterweight	4-852-204-00	(A) Spacer
3-701-623-00	(A) Bag, plastic; power cord (UK model)		

Note: The components identified by shading are critical for safety. Replace only with part number specified.